

Hunter video Wall Controller 5 x 9 4K@60hz

User Manual

**9151-HUS-VW5x9- Hunter video Wall
Controller 5 x 9/ 4K**

www.hunterindia.in



Product Introduction

Hunter 5x9 video wall controller support 4 way HDMI/1way DP input,10 way HDMI output,the main function is to divide a complete HDMI HD image signal into 9 pieces and then be assigned to 9 video display unit((such as Rear projection unit, LCD TV, etc).Complete with 9 HDMI high-definition video display units to form a large dynamic image screen.

At the same time, the 4-way hdmi HD signal can be displayed on the screen, and has a variety of video segmentation effects.

It is mainly used in ultra-high definition video surveillance, large screen wall, store advertising screen, exhibition screen and other industry applications



Features

- Supports 4way HDMI input (1way 4k@60hz, 3way 4k@30hz)
- 1way DP input (4k@60hz)
- 9way HDMI output (1080p@60hz),1 HDMI loop out (picture is consistent with the splicing picture),one 3.5mm headphones stereo output.
- Single device, 5 in 9 out (1x1~4x4 compatible)
- Various splicing modes: horizontal /vertical / 2x2,and support the large-scale cascade and parallel use with loop out port.
- Maximum full screen 4 segmentation, support a variety of segmentation modes(Single picture, double picture with picture in picture, four picture segmentation),any input source
- Channels can be allocated to the split screen.
- Input resolution up to 3840x2160@60Hz,down ward compatible one output resolution
- support up to 1920x1080@60hz(Output supports custom standard resolution).

- Input supports full-screen 90° rotation (support only single-screen mode),the output
- Supports the first row of 180 ° rotation(Support only in splicing mode when two rows)
- No stretching, no deformation, no need to compress the input source, the picture is clear.
- Support for remote control, button, RS232 control.

Specifications

HDMI input resolution	the highest support 3840x2160/60Hz
HDMI output resolution	the highest support 1920x1080/60Hz
Support audio format	stereo
Input cable length	≤5m AWG26 HDMI standard cable
Output cable length	≤5M,AWG26
Max working current	1A
Power adapter specifications	input AC (50HZ, 60HZ) 100V-240V Output 12V DC/2A
Operating Temperature range	(-10°C~ +45°C)
Dimension (L x W x H)	305x184x37(mm)
Weight	1720g

Connection Diagram

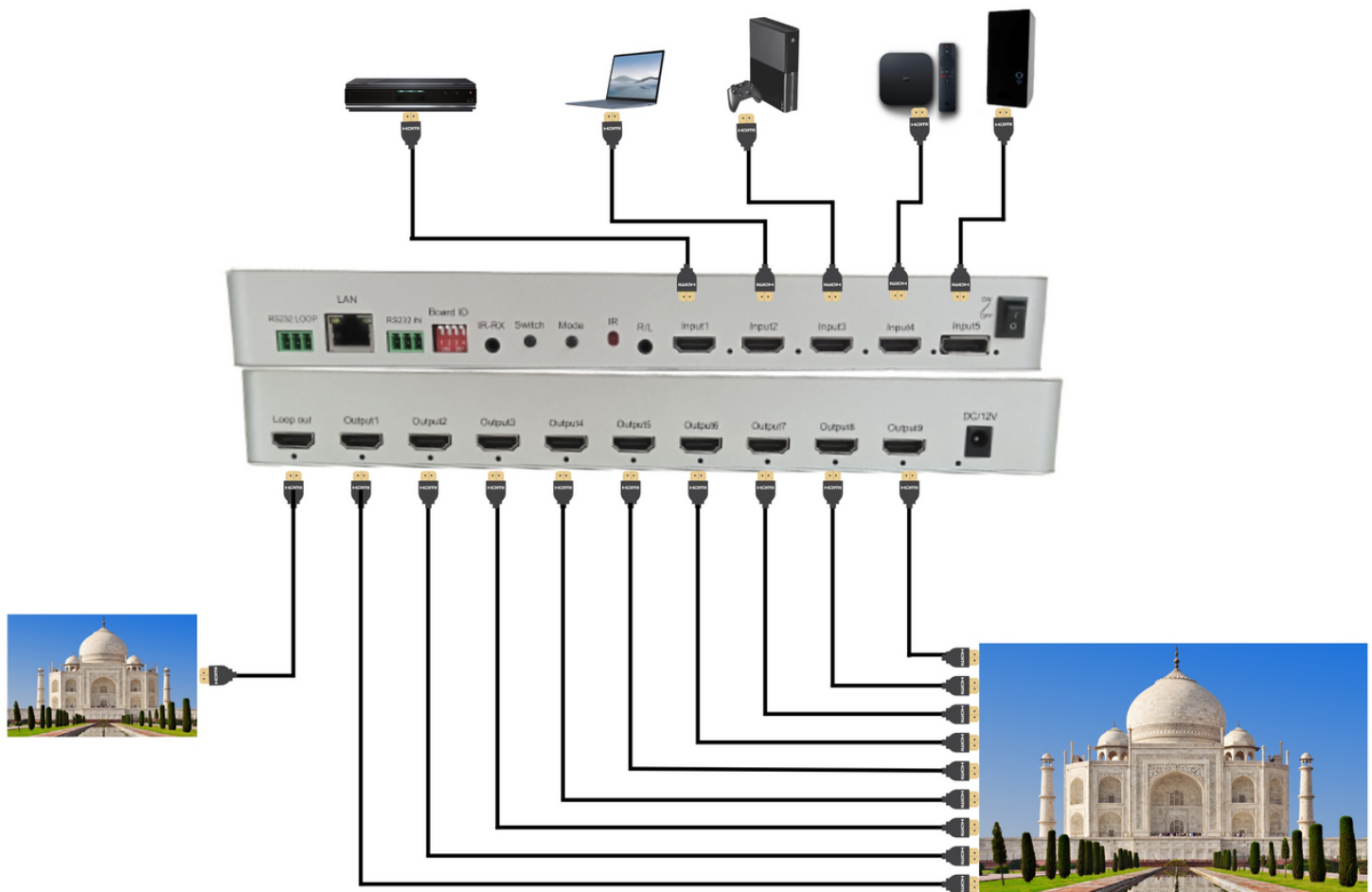

Remote control



Row: Set the splicing mode: row (range: 1-16)

Column: Sets the splicing mode: column (range: 1-16)



OK: Confirm button

Cancel: Cancel button



Window: Number of each picture (window) in [whole screen], see Note1 for details.

Input source: Input the number of the source, such as: 1 for HDMI①, 2 for HDMI②



+: use with [zoom], realize the picture in picture small window function [move left / move right / amplification / narrowing]

-: use with [zoom], realize the picture in picture small window function [move left / move right / amplification / narrowing]

Zoom: Small window left/right move menu - Small window up/down move menu - - -> Small window amplification/narrow menu



2x2/3x3/1x3/3x1: Four commonly used splicing mode buttons

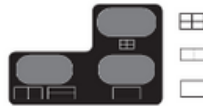

: Four picture segmentation

: Dual picture (left and right segmentation-->upper and lower segmentation)

: Single-screen switch: HDMI①→HDMI②→HDMI③→HDMI④→DP⑤

90°Flip: Whole input image rotation of 90°(only in single picture)

180°Flip: The first row output image rotates 180°(in two rows only)

1x1: Single display mode: each output port replication displays (1x1)

www.hunterindia.in

Note 1:

[Window] button meaning:the number of each picture (window) in the "whole screen", the corresponding picture position is as follows:

1. single picture mode: only one picture, it is fixed as number A, the figure below.



2. Double picture-picture in picture mode: large picture is number A, small picture is number B, the figure below:

A B



3. Double picture-left and right mode: left picture is number A, right picture is number B, the figure below:

A B



4. Double picture-up and down mode: upper picture is number A, lower picture is number B, the figure below:

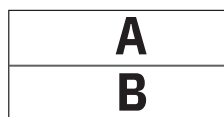

5. Four picture mode: the upper left picture is number A, the bottom left picture is number B, the upper right picture is number C, the bottom right picture is number D, the figure below:

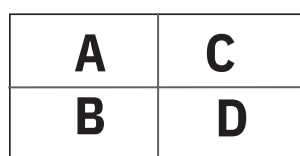

Product interface:

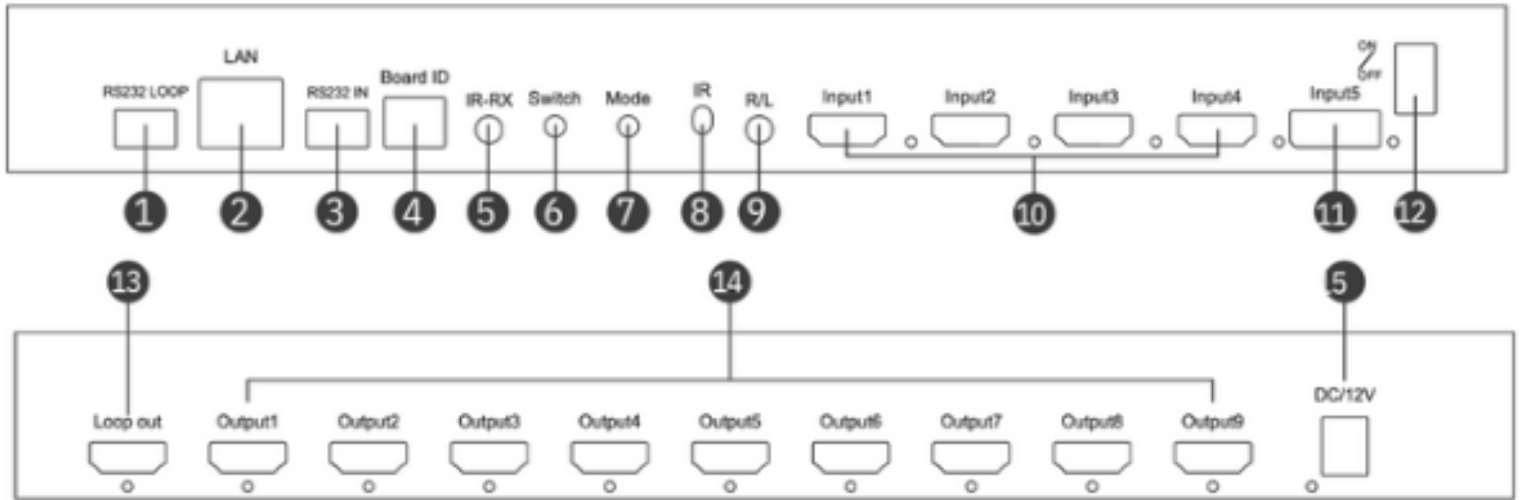

- 1: RS232 LOOP - RS232 control loop out for the cascading mode to RS232 instruction loop out to the next device.
- 2: Lan - Rj45 port, the TCP network protocol, is used for the host machine issuing command control device.
- 3: RS232 - RS232 control equipment for issuing RS232 instruction control equipment.
- 4: Board ID - Represents the ID of the current device in cascade mode, as shown in below Note2 for details.
- 5: IR-RX - Receiving remote control signal, it required an external IR receiver.
- 6: Switch - Switch the splicing mode.
- 7: Mode - Screen segmentation mode switch.
- 8: IR - Infrared reception window, remote control signal reception.
- 9: R/L - Audio output interface for audio output equipment: headphone and amplifier etc.
- 10: Input1-4 - 4 HDMI input interfaces.
- 11: Input5 - 1 DP input interface.
- 12: ON/OFF - Power on off.
- 13: Loop out - HDMI loop out (loop out picture is consistent with splicing picture)
- 14: Output1-9 - 9 HDMI output interfaces
- 15: DC/12V - 12V power supply.

Note 2: DIP switch (1 up; 0 down)

1. Meaning: indicates the ID number of the current device when cascading Set in binary.

ID number	Device 1	Device 2	Device 3	Device 4	Device 5	Device 6	Device 7	Device 8
Binary value	1000	0100	1100	0010	1010	0110	1110	0001
ID number	Device 9	Device 10	Device 11	Device 12	Device 13	Device 14	Device 15	
Binary value	1001	0101	1101	0011	1011	0111	1111	

Connection Diagram - Splicing Mode

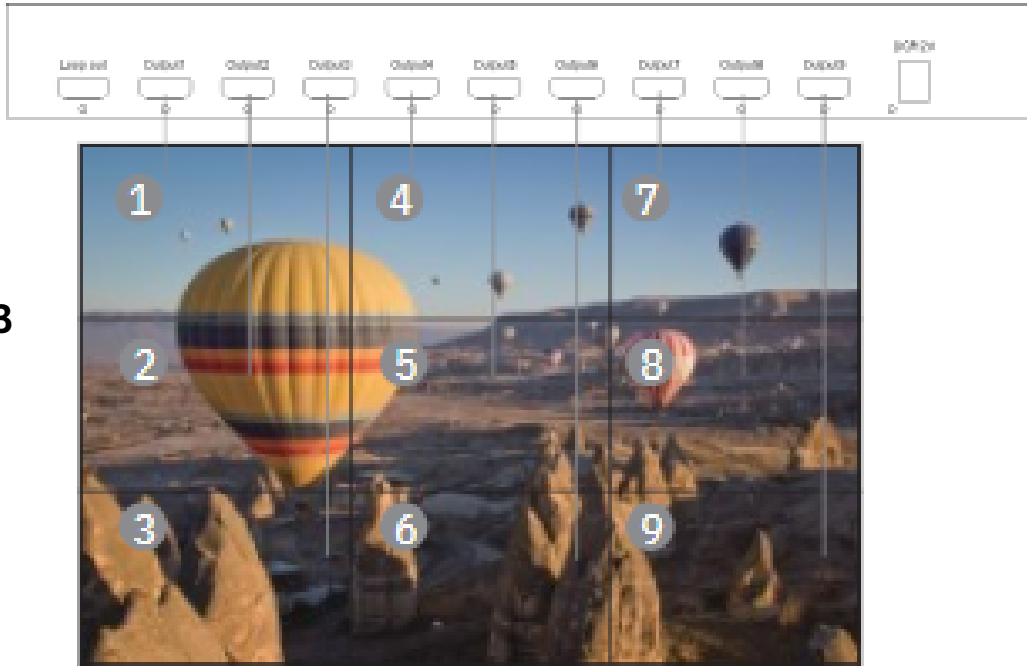

Example 3x3

Connection Diagram - Splicing Mode Cascade Panel

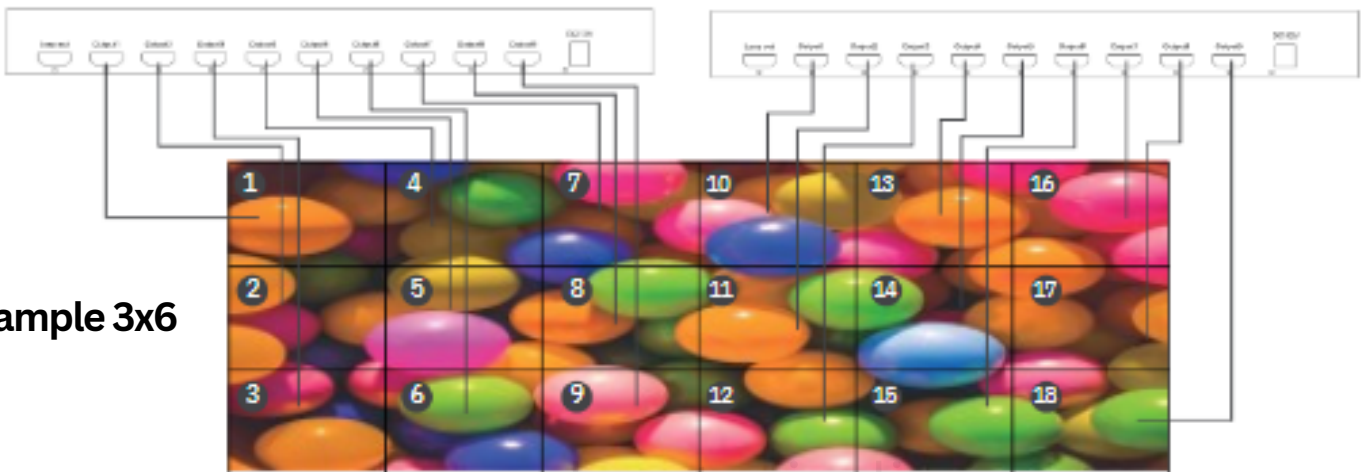

Example 3x6

Attached: software operation:

1. Please choose green edition and click exe file.

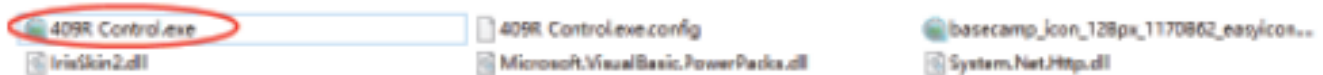

2. Serial port mode operation: A. First click "RS232 Mode" and click "Clear Serial", find the corresponding com port in the "Serial port", Click "Confirm Mode" to refresh the connection status. Finally, click "Connect" to complete the serial port communication.

Four Screen Split Mode:



Left & Right Dual Picture



Picture In Picture

Splicing of 9 Screens:

www.hunterindia.in

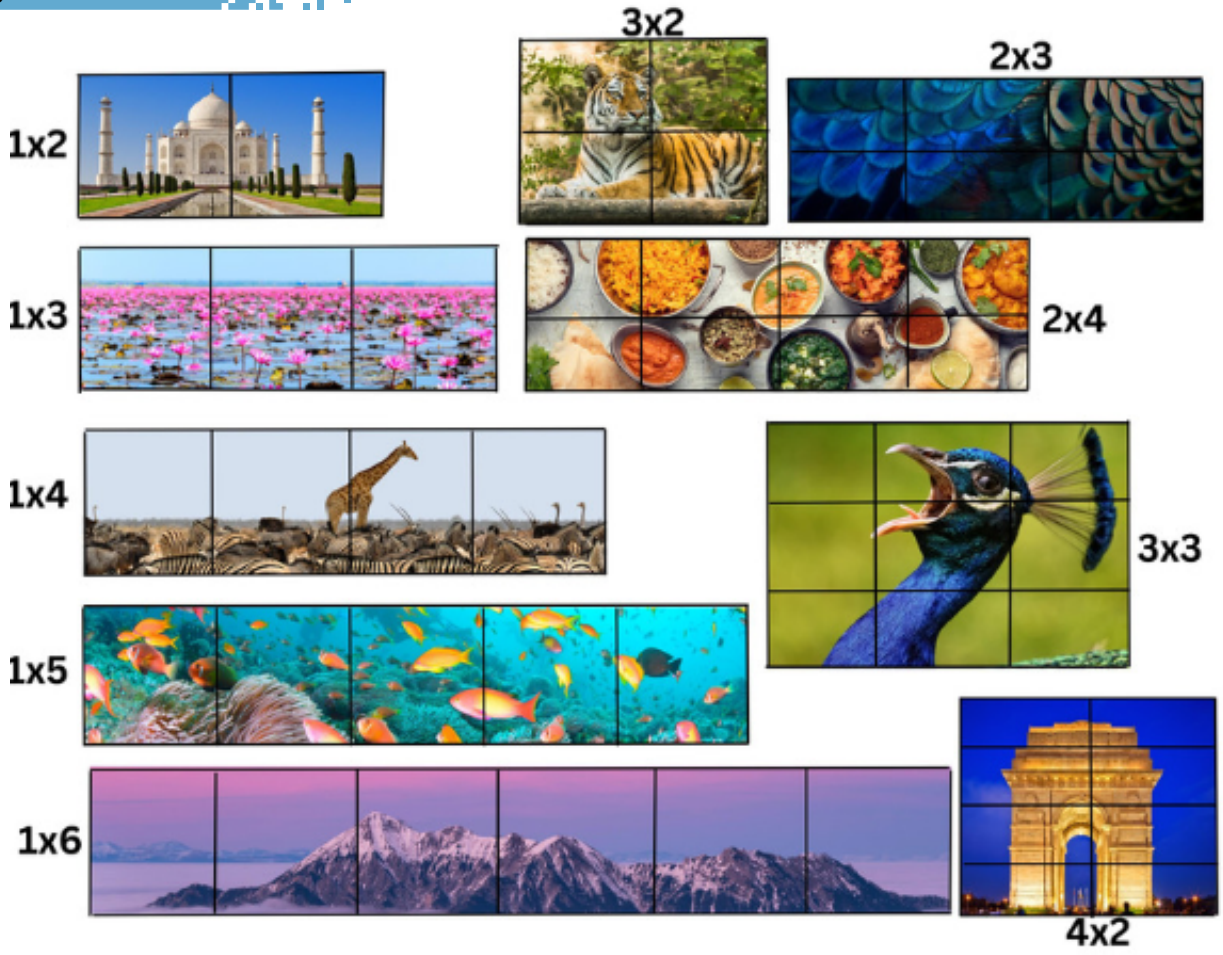

Note:How to view the COM port,you need to right-click "Start" at the windows icon---Open the "Device Manager", find the serial port available for the computer; the baud rate is fixed to 9600 and is not changeable.



3: The second step is to set up the splicing mode,you can enter the Column and Row, or click on the corresponding mode,Click "OK" to complete the settings.



4.The third step is to change the input window mode,include Single, Left-Right, Up-Down,PIP and Four window.



5: The fourth step is to select the corresponding input source for the output window,there are two ways:

- ① Drags the input source directly to the corresponding window;
- ② Or select a window, and then click the input source that you want to select.



6: Application of PIP mode:on the right side of the panel, the small window can be operated in amplification and narrow move.



Hunter 5x9 video wall

Package Content

Hunter video Wall Controller 5 x 9 4K

Remote Control

RS232 cascade cable

RS232 serial cable

12V DC power adaptor

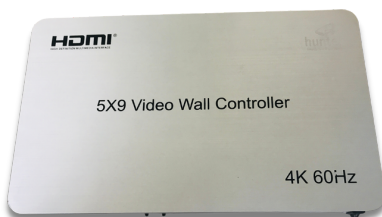

Applications



Outdoor video wall



Monitor room



Shopping mall video wall

www.hunterindia.in

Splicing mode resolution

Mode	Input resolution	Output resolution	Single screen resolution
1x2	3840x1080@30Hz	3840x1080@60Hz	1920x1080@60Hz
1x3	3840x720@30Hz	5760x1080@60Hz	1920x1080@60Hz
1x4	3840x540@60Hz	7680x1080@60Hz	1920x1080@60Hz
1x5	3840x432@60Hz	9600x1080@30Hz	1920x1080@60Hz
1x6	3840x360@60Hz	11520x1080@60Hz	1920x1080@60Hz
2x1	1920x2160@30Hz	1920x1080@60Hz	1920x1080@60Hz
2x2	3840x2160@30Hz	3840x2160@60Hz	1920x1080@60Hz
2x3	3840x1440@30Hz	5760x2160@60Hz	1920x1080@60Hz
2x4	4096x1152@30Hz	7680x2160@60Hz	1280x720@60Hz
3x1	1920x3240@30Hz	1920x3240@60Hz	1920x1080@60Hz
3x2	2816x2376@30Hz	3840x3240@60Hz	1920x1080@60Hz
3x3	3840x2160@30Hz	3840x2160@60Hz	1280x720@60Hz
4x1	1776x3996@30Hz	1920x4320@60Hz	1920x1080@60Hz
4x2	2560x2880@30Hz	2560x2880@60Hz	1280x720@60Hz
5x1	1408x3960@30Hz	1920x5400@60Hz	1920x1080@60Hz
6x1	1184x3996@30Hz	1920x6480@60Hz	1920x1080@60Hz
7x1	992x3906@30Hz	1280x5040@60Hz	1280x720@60Hz
8x1	880x3960@30Hz	1280x5760@60Hz	1280x720@60Hz
9x1	784x3969@30Hz	1280x6480@60Hz	1280x720@60Hz



Cascade mode resolution

Mode	v Input resolution	Output resolution	Single screen resolution
2x5	4080x918@30Hz	6440x1440@60Hz	1280x720@60Hz
2x6	4080x765@30Hz	7680x1440@60Hz	1280x720@60Hz
2x8	4096x576@30Hz	10240x1440@60Hz	1280x720@60Hz
2x10	4032x504@30Hz	12800x1440@60Hz	1280x720@60Hz
2x12	4032x378@30Hz	15360x1440@60Hz	1280x720@60Hz
3x4	4096x1728@30Hz	5120x2160@60Hz	1280x720@60Hz
3x5	4080x1377@30Hz	6400x2160@60Hz	1280x720@60Hz
3x6	4032x1134@30Hz	7680x2160@60Hz	1280x720@60Hz
3x8	4096x864@30Hz	10240x2160@60Hz	1280x720@60Hz
4x4	4096x2304@30Hz	5120x2880@60Hz	1280x720@60Hz
4x5	4080x1836@30Hz	6400x2880@60Hz	1280x720@60Hz
4x6	4032x1512@30Hz	7680x2880@60Hz	1280x720@60Hz
5x2	2048x2880@30Hz	2560x3600@60Hz	1280x720@60Hz
5x3	3024x2835@30Hz	3840x3600@60Hz	1280x720@60Hz
5x4	3008x2115@30Hz	5120x3600@60Hz	1280x720@60Hz
5x5	4080x2295@30Hz	6400x3600@60Hz	1280x720@60Hz
6x2	1920x3240@30Hz	2560x4320@60Hz	1280x720@60Hz
6x3	2640x2970@30Hz	3840x4320@60Hz	1280x720@60Hz
6x4	3072x2592@30Hz	5120x4320@60Hz	1280x720@60Hz
8x3	2160x3240@30Hz	3840x5760@60Hz	1280x720@60Hz

Loop resolution

Mode	Loop resolution
1x1	1920x1080@60Hz
1x2	1x6 3840x1080@60Hz
1x7	1xN 3840x720@60Hz
2x1	6x1 1920x2160@60Hz
7x1	Nx1 1280x3600@60Hz
2x2	3840x2160@30Hz
2x3	2xN 3840x1440@30Hz
3x2	2560x2160@30Hz
N<3 x 2	2560x1440@30Hz
N<2 x N>2	3840x2160@30Hz